

# Side Mirror Lock Folding

---

- DATE : 2020.02.01



**GU ELECTRONIC**

# Index

---

1. Main Spec
2. Block Diagram
3. Dimension
4. Connector Pin Assignment
5. Product Composition
6. DIP S/W Setting
7. ON/OFF Control
8. Install
9. Q&A

# 1. Main Spec.

---

## 1. Input Spec.

- 1 x High Speed CAN

## 2. Output Spec.

- 2 x LIN(IN/OUT)

## 3. Power Spec.

- Input Power : 8VDC ~ 24VDC
- Consumption Power : 12Watt, Max

## 4. Switch Input mode

- Possible to select CAR model while switching mode by DIP S/W

## 2. Block Diagram

---

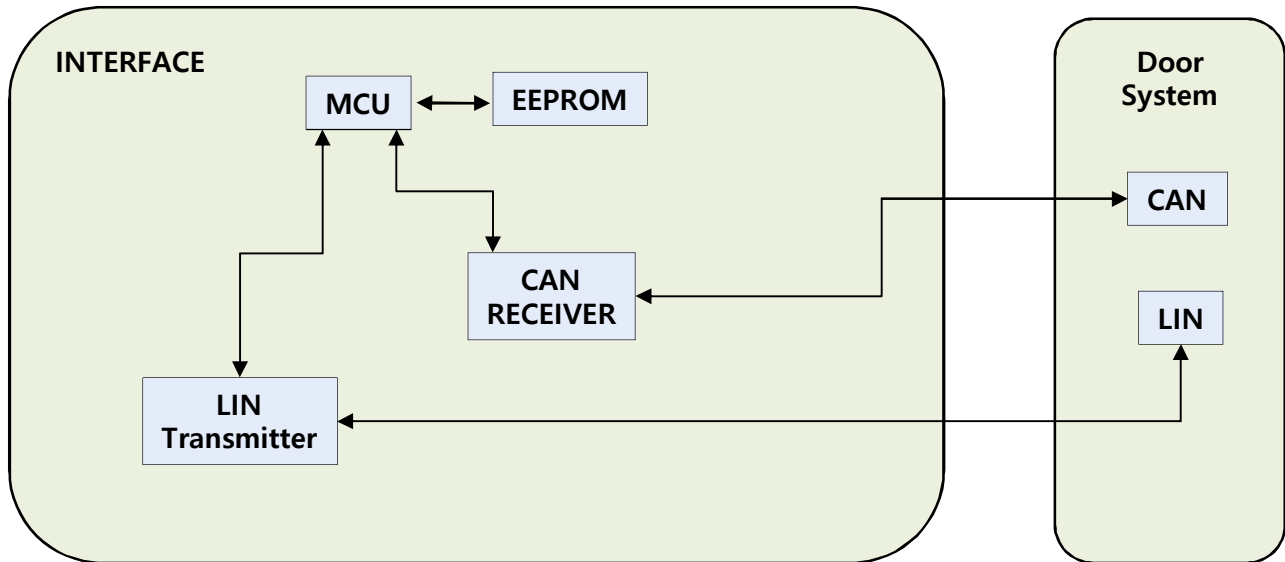

# 3. Dimension

---

72mm \* 45mm \* 20mm









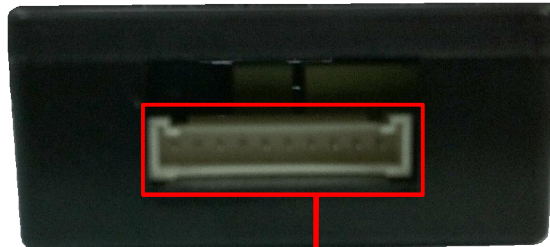



\* This can change under manufacturer's circumstance

# 4. Connector Pin Assignment

---



\*POWER Connect

									
①	②	③	④	⑤	⑥	⑦	⑧	⑨	⑩

- ① BATTERY (Red)
- ② N.C
- ③ N.C
- ④ GND (Black)
- ⑤ LIN out (Blue)
- ⑥ LIN in (Green)
- ⑦ N.C
- ⑧ N.C
- ⑨ CAN-L in (White)
- ⑩ CAN-H in (Brown)

# 5. Product Composition

---



SMLF 1 EA

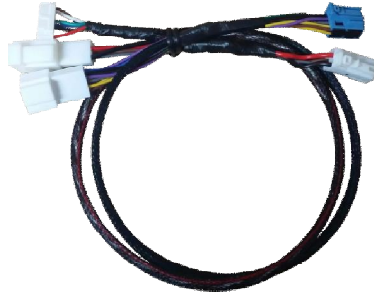

Power Cable 1 EA

# 6. DIP S/W Setting

---

## \* DIP S/W Example



JEEP 2014year Grand Cherokee



JEEP 2009~2013year Grand Cherokee



CHRYSLER 300C  
MASERATI 2014year Quattroporte/Ghibli



JEEP 2014year Cherokee(KL)



# 7. Jeep/Maserati control

---

MASERATI 2014year Quattroporte/Ghibli

JEEP 2014year Grand Cherokee

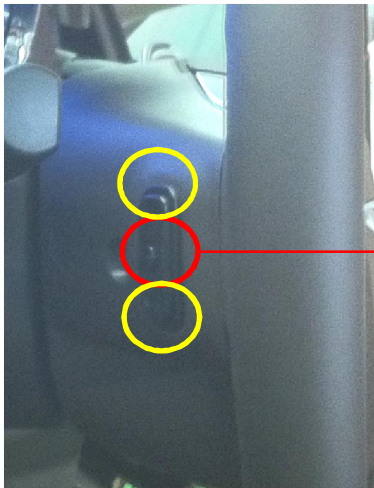

Streeing wheel button  
Left Center  
ON / OFF when pressed for 10 seconds

# 8. Install Manual

---

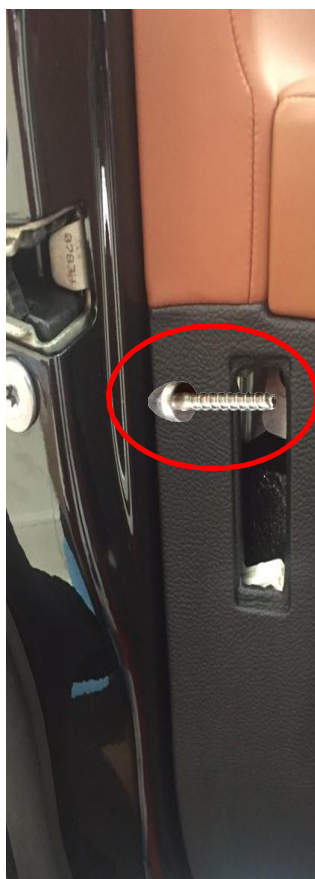

# 8. Install Manual

---

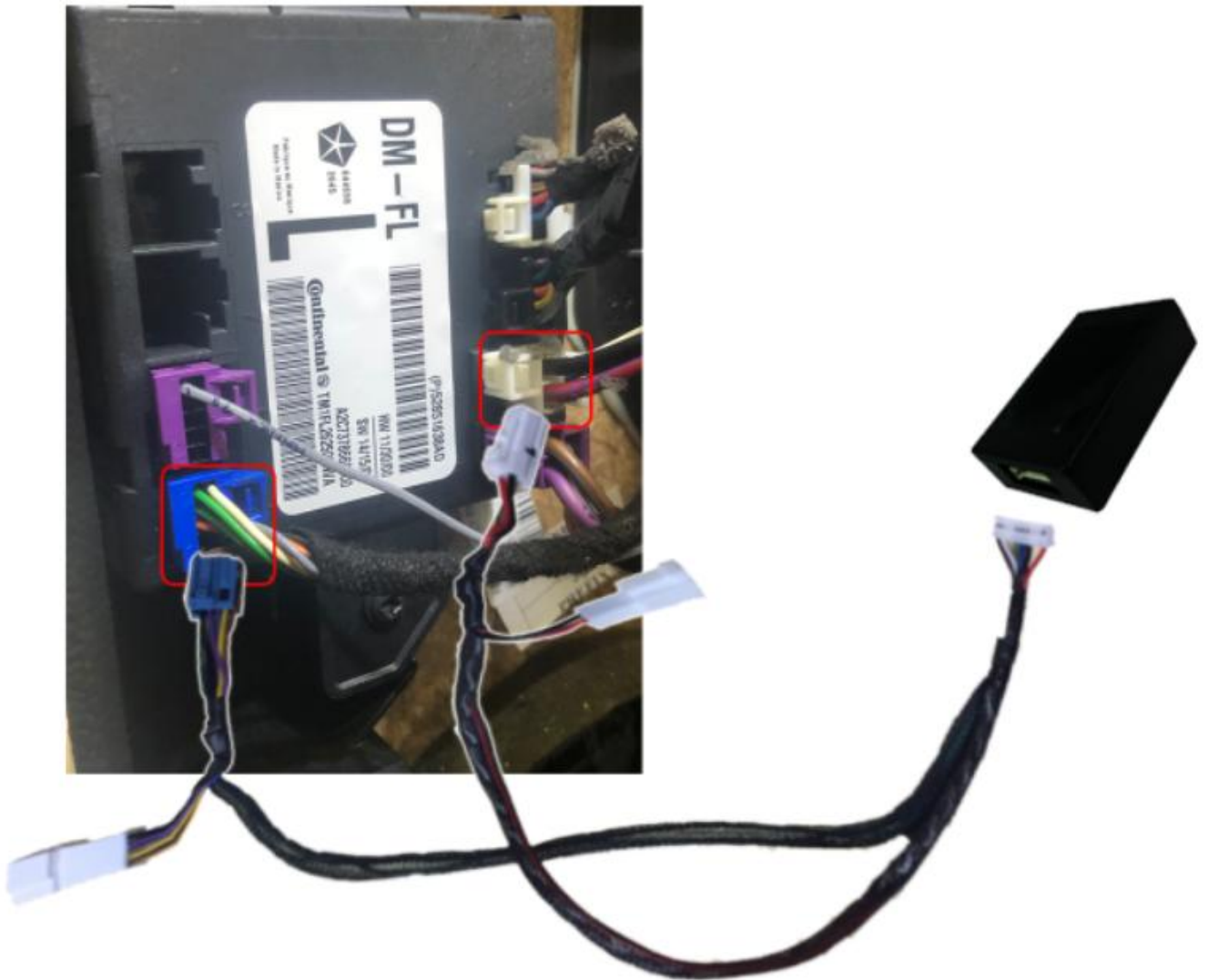

## 9. Q & A

---

1. After the installation is complete, start with:
2. Press the button to forcibly fold the side preview.
3. Lock the vehicle with the remote control.
4. After 5 minutes, open the vehicle with the remote control and the side mirror will be activated